

LED INDICATOR VERSION IDENTIFICATION

There are two version of the LED Indicator. To determine which version you have take a look at the sensor on the bottom of the Indicator. If it is square in shape it is version 2. If it is a circle then you have version 1.

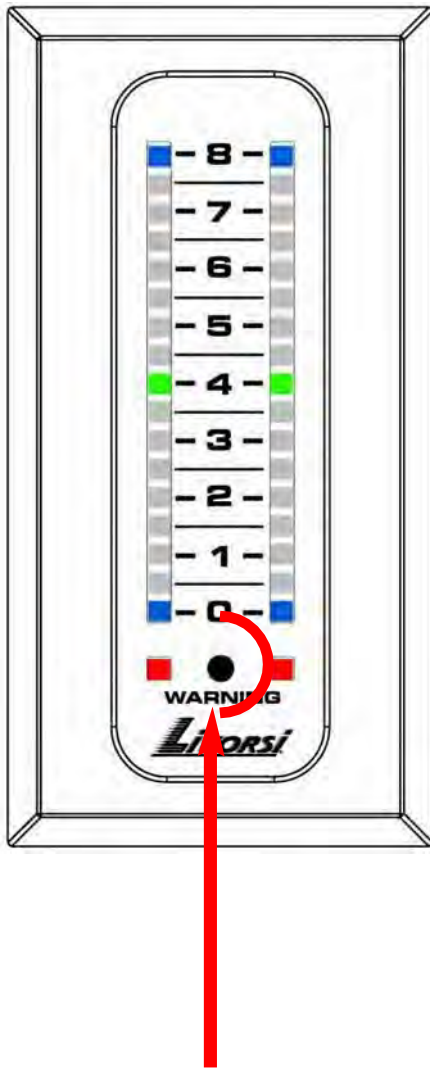

Circle Shape Sensor = Version 1

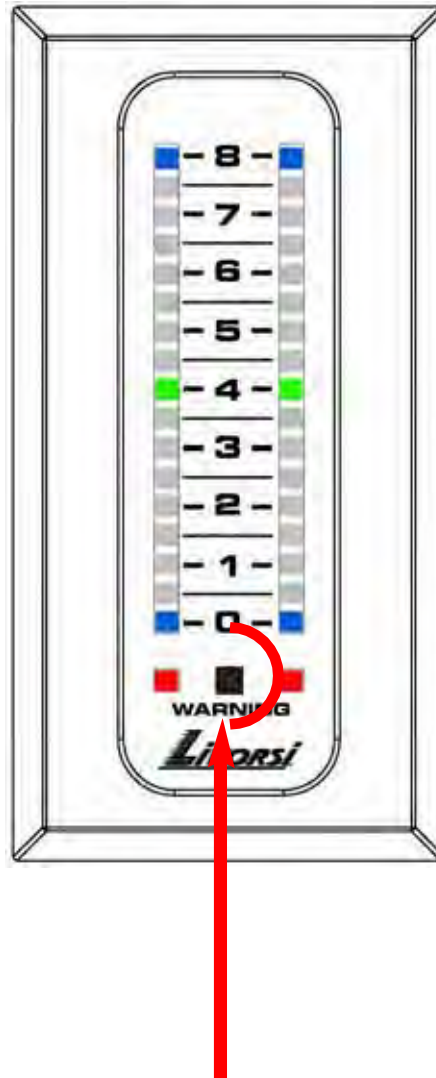

Square Shape Sensor = Version 2

LED Position Indicator Installation and Calibration Instructions

VERSION 2

Congratulations on the purchase of your Livorsi LED Position Indicator.

The following instructions will take you step by step throughout the calibration process. LED indicators are sold in multiple configurations: 1, 2, 3, and 4 slot assemblies. These instructions illustrate a one slot indicator but will also serve 2, 3 and 4 slot applications.

Please read the entire procedure before attempting the calibration process. Pay special attention to the set up of your Optimal Running Angle a.k.a. Sweet Spot.

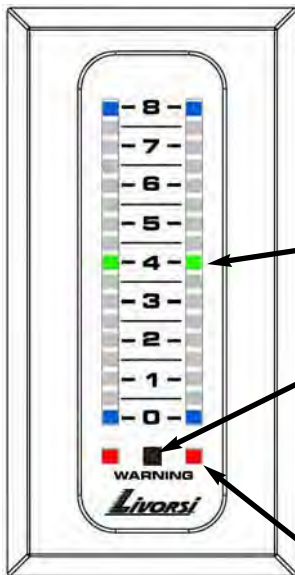

General Terms to be familiar with:

Optimal Running Angle a.k.a. "Sweet Spot" - Green LED

Sensor

The sensor is used to calibrate the LED indicator. The sensor will detect motion during the calibration process.

Cover and Sweep

A cover of the sensor with your finger and sweep motion over the sensor will be utilized to calibrate the indicator. **Note:** This is a proximity sensor not a push button. The sensor detects motion not pressure.

Warning LED with optional sender - Red LED

You may utilize a warning for your application with an optional sender.

Entering Access Mode (all ALEDI models)

When power is applied the LED indicator will go through its start up cycle. During this cycle calibration mode access will be obtained by a cover and sweep motion.

If at any time during the calibration process a mistake is made, simply turn power off and start from the beginning of the calibration process.

NOTE: Step 1 is time critical

You will have approximately **15 seconds** to access calibration mode. If calibration is not accessed the indicator will return to normal operation. Once in calibration mode the indicator will return to normal operation **after 3 minutes of no activity**.

NOTE.... Fluid level calibrations are NOT time critical

Step 1: Entering calibration mode

- A. Cover sensor with finger and hold
- B. Apply power / Turn unit on
- C. While the indicator is going through its start up cycle, slide finger off the sensor
You should see the top blue / middle green / bottom blue LED'S illuminated.
- D. Cover sensor with finger, the top blue / middle green /bottom blue LEDs will go bright at this point sweep away

You should see the LEDs running in a fill bar configuration.

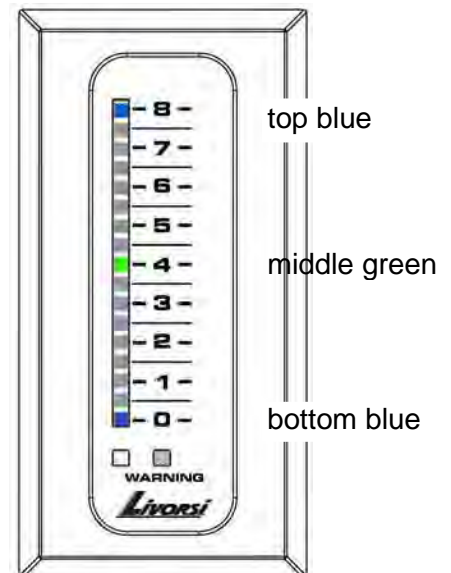

You are now in calibration mode.

After entering the calibration mode you should see one of these two examples:

Figure A:
In a horizontal application the LED'S running from right to left in a ascending fill bar configuration.

Figure A

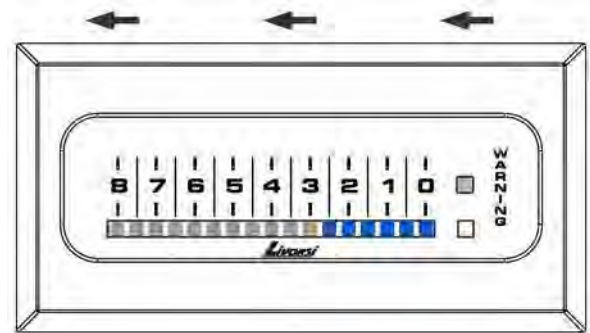
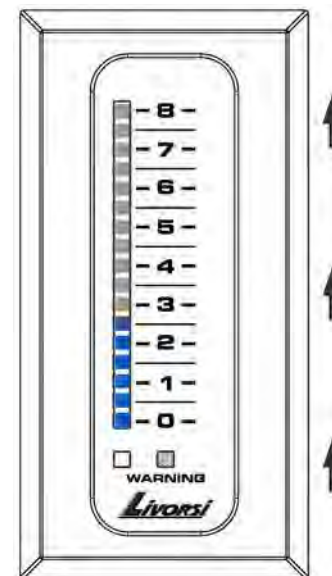

Figure B:
In a vertical application the LED'S will run in an bottom to top ascending fill bar configuration.

Figure B



If you did not make it into calibration mode, turn power off and try again.

Step 2: Setting desired LED configuration- single LED or fill bar

- A. To change the configuration cover the sensor for **1 second** and sweep away
 You will need to repeat the cover and sweep motion until you have reached the configuration of your choice

The order of configurations is as follows:

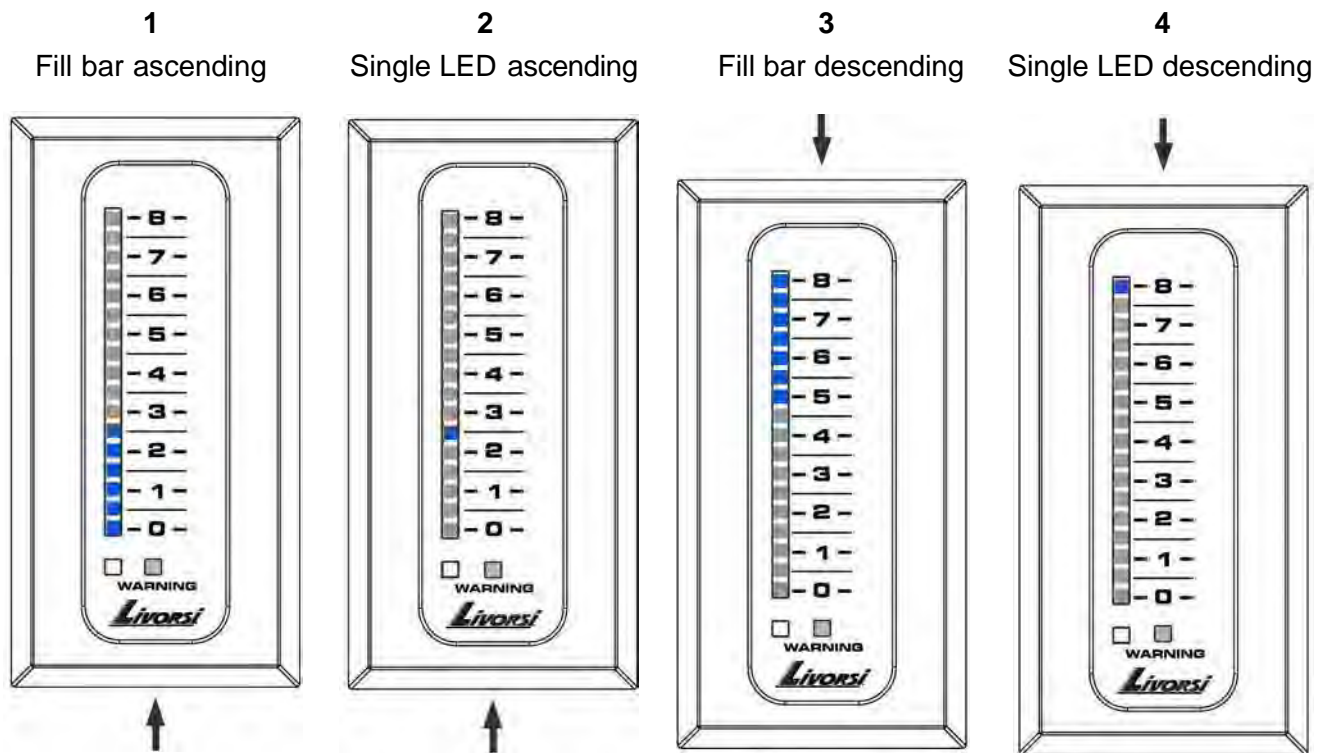

- B. Once you have reached the desired configuration cover the sensor
 The LED lights will go dim then go bright- at this point sweep away

For a 1 slot indicator continue to step 3

In a 2-slot application the indicator will have transferred to the second row of LED'S.
 Repeat steps 2A and 2B for desired calibration

Step 3: Setting the bottom/low side top/high side of the indicator

At this point you will have only one LED illuminated.
This will be the bottom / low side set point

If **ascending** this will be the bottom / low side set point

If **descending** this will be the top/high side set point

A. At this point the item that is assigned to the indicator

I.E.... Outboard motor, outdrive, trim tabs, Etc...

must be moved to the first set point

I.E.....Outdrives / vertical **ascending** configuration...
fully lower Outdrive (s)

I.E....Trim tabs / Vertical **descending**
configuration...fully raise trim tabs

B. Once item is properly positioned cover the sensor
The LED lights will go dim then go bright at this point
sweep away.

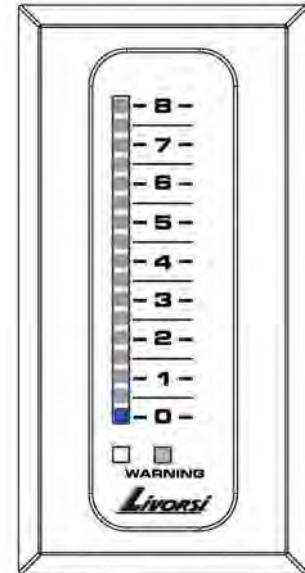

Example: ascending verticle/
low side

For a 1-slot applications proceed step 4

For 2-slot applications the indicator will have transferred to the
second row of LED'S.

Repeat steps 3A-3B for the second row of LED'S

Step 4... Setting the low / high side of the indicator

At this point you will have only one LED illuminated.
This will be the low / high side set point

A. At this point the item that is assigned to the indicator

I.E.... Outboard motor, Outdrive, Trim tabs, Etc...
must be moved to the low / high side point

I.E....Outdrives / vertical **ascending** configuration...
fully raise Outdrive

I.E....Trim tabs / Vertical **descending** configuration...
fully lower trim tabs

B. Once the item is properly positioned to the low / high side
set point, cover proximity sensor the LED lights will go dim
then go bright at this point sweep away.

For a 2-slot application the indicator will have transferred to
the second row of LEDS

Repeat step 4A and 4B for the second row of LED'S

Step 5...Saving your calibration

With the completion of step 4 you will see the top blue,
middle green and bottom blue LED'S illuminated.

You must now save your calibration.

A. To save the calibration, cover the sensor. The LED lights
will go dim then go bright and the red warning LED will
illuminate. At this point sweep away.

The LED indicator is now ready for use

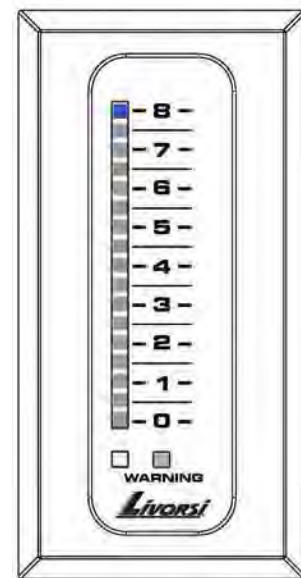

**Example: ascending verticle
top/high side**



LED Position Indicator Installation and Calibration Instructions VERSION 2

Step 5: Setting optimal running angle (sweet spot)

For fluid calibration see page 9

Setting optimal running angle (sweet spot) will allow you to set the midpoint green LED to your desired drive and trim tab position quickly. Once this procedure is completed simply position drive or trim tab until the green LED is lit. Drive and trim tabs will have returned to your desired position.

This procedure has been greatly simplified in version 2 of the Livorsi LED indicator

Before performing this procedure thoroughly read instructions first so this procedure can be completed safely

Step 1

Drive boat and adjust drives, trim tabs, jack plate, ETC... until you have achieved the desired position of the drives, trim tabs, jack plate, ETC...

Step 2

Without repositioning drives, trim tabs, jack plate, ETC... **reduce speed and safely stop.**

Step 3

1... Cover the LED indicator sensor until the red warning light appears then sweep away.

2... Immediately recover the LED indicator sensor until the red warning appears then sweep away. **You will now see the top blue, middle green, and bottom blue LED'S illuminated.**

3... Immediately recover the LED indicator sensor. The top blue, middle green and bottom blue LED'S will go bright. At this point sweep away. The LED indicator will now be displaying the midpoint green LED.

4... The optimal running angle (sweet spot) calibration is now complete and your Livorsi LED indicator is ready for normal use.

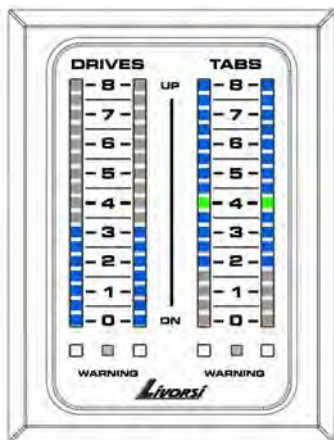

Note: This indicator is calibrated for drives ascending and tabs descending. Drives at #3 and tabs #2.

Fluid Level Calibration (OPTIONAL)

NOTE THE BOTTOM LED WILL REMAIN illuminated WHEN TANK IS EMPTY!!! (photo is showing indicator as empty)

During initial programming, all Livorsi LED indicators are calibrated to empty (0%) and full (100%) per customer's request. In most cases when using the Livorsi LED indicator for fluid level information the Livorsi LED indicator can be installed and will perform well without performing the calibration process.

Example... Standard Marine Fuel Level Empty 240 Ohm / Full 33 Ohm In most cases the indicator can be installed and will operate correctly.

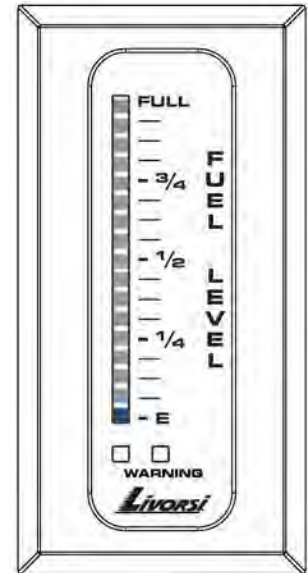

In some cases due to length of sending wire, degraded wiring, multiple connection points, switches, etc.... ohm or voltage values can be effected and cause the indicator to read inaccurately.

Example:

You fill your tank and the very top LED is not illuminated. In this case the indicator will need to be calibrated to your system. In all cases it is best to perform the calibration process using the actual sender in the system and at the senders normal location. This will take all the system wiring into account when calibrating.

Entering Fluid level Calibration

1. Cover sensor with finger
2. Apply power / Turn unit on
3. While the indicator is going through its start up cycle, sweep finger off sensor. You should see the top blue / middle green / bottom blue LED'S illuminated.
4. Cover sensor with finger, the top blue / middle green / bottom blue LEDs will go bright. At this point sweep away. You should see the LEDs running in a fill bar configuration.
5. Choose fill bar or single LED (see step two)
6. Cover sensor LED'S will go dim then bright. Sweep away.
7. The bottom LED will be illuminated. Move sender to the empty position. Cover sensor. The LED will go dim then bright. Sweep away
8. The indicator will now show the top LED illuminated. Move sender to the full position. Cover sensor. LED's will go dim then bright. Sweep away.
9. The indicator will now show the top, middle and bottom LED's illuminated. Cover sensor. The LED'S will go dim then bright and the red warning LED will illuminate. Sweep away. The indicator is now calibrated and ready for normal operation.



Fluid Level Tank Calibration (OPTIONAL)

In most cases when using the Livorsi LED indicator for fluid level information the Livorsi LED indicator can be installed and will perform well without performing the tank calibration process.

In some cases due to oddly shaped tanks (Barrel tanks, Tapered tanks, Deep V tanks, etc...) the Livorsi LED indicator can be calibrated to the tank for superior accuracy.

Fluid level calibration must be performed prior to fluid level tank calibration

NOTE: Before attempting this procedure

1. The tank capacity must be known
2. The tank must be empty
3. Power to the Livorsi LED Indicator **MUST** be maintained throughout the **ENTIRE** calibration process. The fluid calibration is **NOT** time critical and will remain in calibration mode indefinitely as long as the indicator is powered

NOTE: The Livorsi LED indicator fluid calibration has three set points. 0%, 50% and 100%

Single row LED indicator. (For dual row indicator see page 11)

Entering Fluid Level Tank Calibration.

NOTE: Tank must be empty before starting

1. Cover the LED indicator sensor until the red warning light appears then sweep away.
2. Immediately recover the LED indicator sensor until the red warning appears then sweep away. The bottom LED will be illuminated. This is 0% (empty) set point.
3. Cover the LED indicator sensor. The LED will go bright then dim. Sweep away. The indicator will be transferred to the middle green LED. This is the 50% set point.
4. Now add 50% of the tanks capacity. Once complete cover sensor. The LED will go bright then dim. Sweep away. The indicator will transfer to the top LED. This is the 100% (full) set point.
5. Now fill tank to full capacity. Once complete cover sensor. The top LED will flash and the top middle and bottom LED will light. Sweep away. The top middle and bottom LED will remain illuminated.
6. Immediately recover the sensor. The top, middle and bottom LED will go bright AND the red LED warning light will light. At this point sweep away. The Livorsi LED indicator is now tank calibrated and ready for use

2-slot Fluid level Tank Calibration

1. Cover the LED indicator sensor until the red warning light appears then sweep away.
2. Immediately recover the LED indicator sensor until the red warning appears then sweep away. You will see one column of LED's illuminated. They will alternate from the left column to the right Column. When the desired Column is illuminated cover sensor. The LED's will go bright then dim. At this point sweep away. The selected column is in tank calibration
3. The bottom LED will be lit. This is 0% (empty) set point.
4. Cover the LED indicator sensor. The LED will go bright then dim. Sweep away. The indicator will transferred to the middle green LED. This is the 50% set point.
5. Now add 50% of the tanks capacity. Once complete cover sensor. The LED will go bright then dim. Sweep away. The indicator will transfer to the top LED. This is the 100% (full) set point.
6. Now fill tank to full capacity. Once complete cover sensor. The top LED will flash and the top middle and bottom LED will light. Sweep away. The top middle and bottom LED will remain lit.
7. Immediately recover the sensor. The top, middle and bottom LED will go bright AND the red LED warning light will lite. At this point sweep away.
8. The Livorsi LED indicator is now tank calibrated and ready for use

LED INDICATOR CUT OUT TEMPLATE

1-2 SLOT HOUSING CUTOUT GEN 3

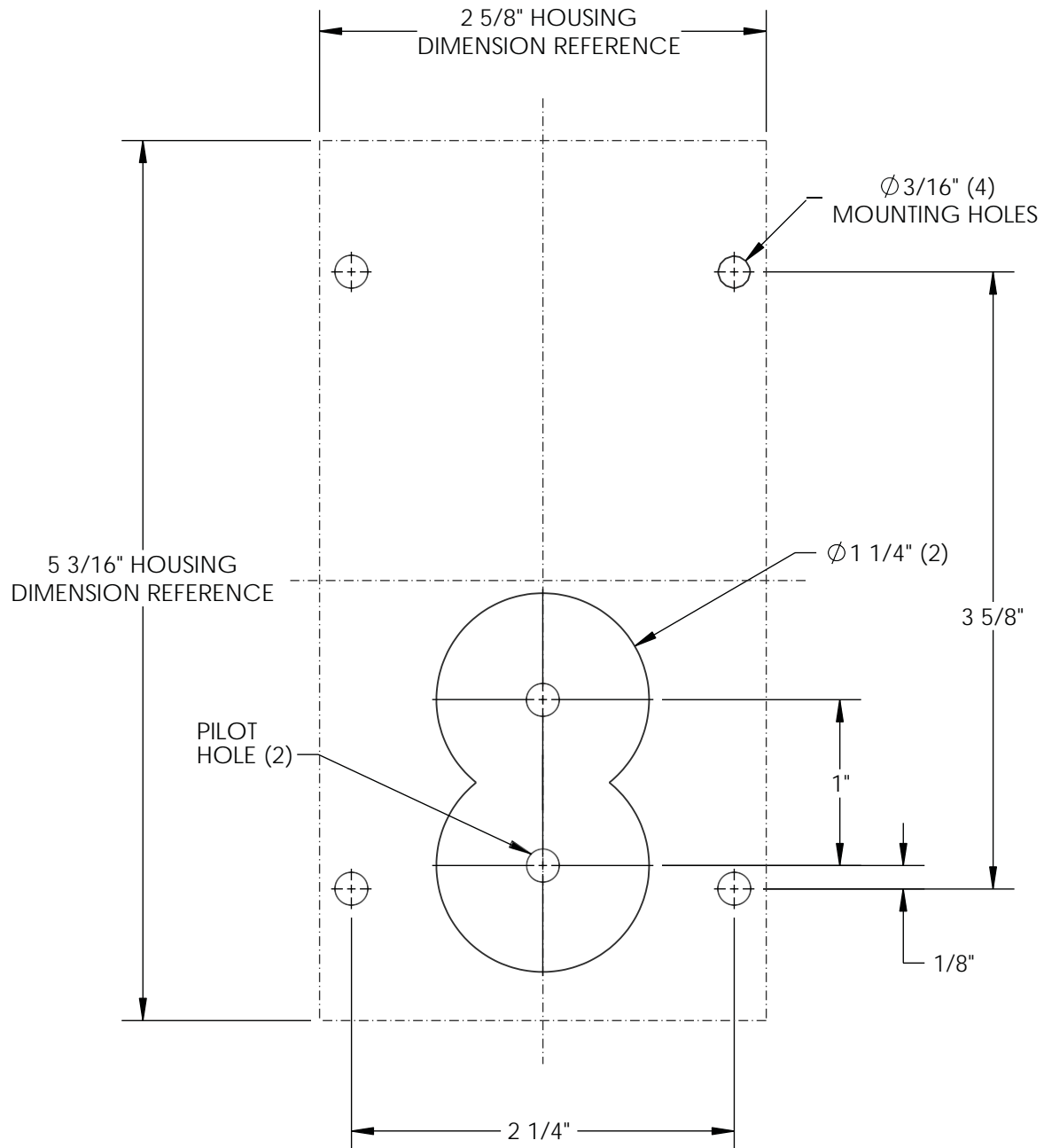

blank on purpose

LED INDICATOR CUT OUT TEMPLATE

3 and 4 SLOT HOUSING CUTOUT GEN 3

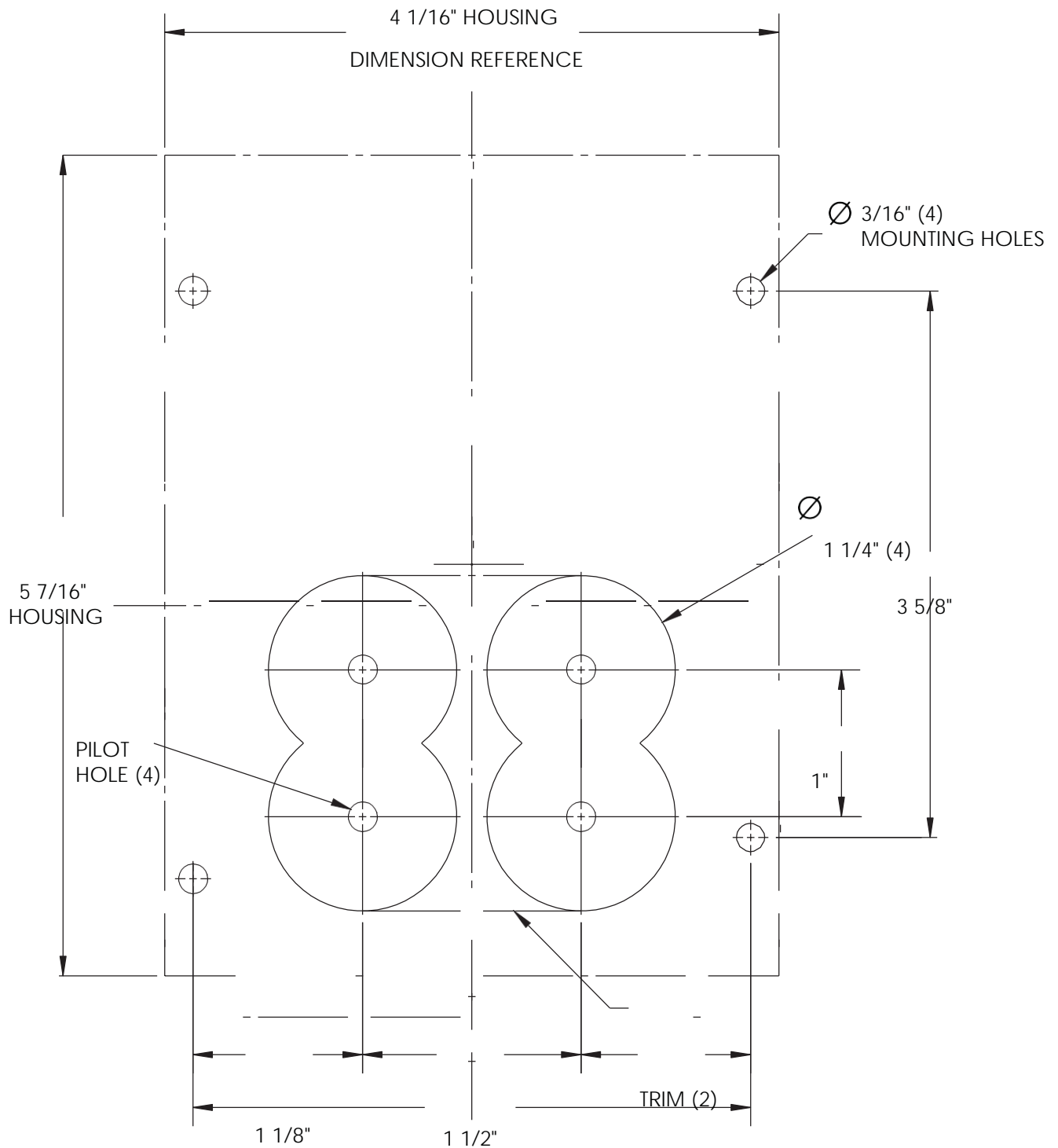



LED INDICATOR CUT OUT TEMPLATE

3 and 4 SLOT HOUSING CUTOUT GEN 3

blank on purpose

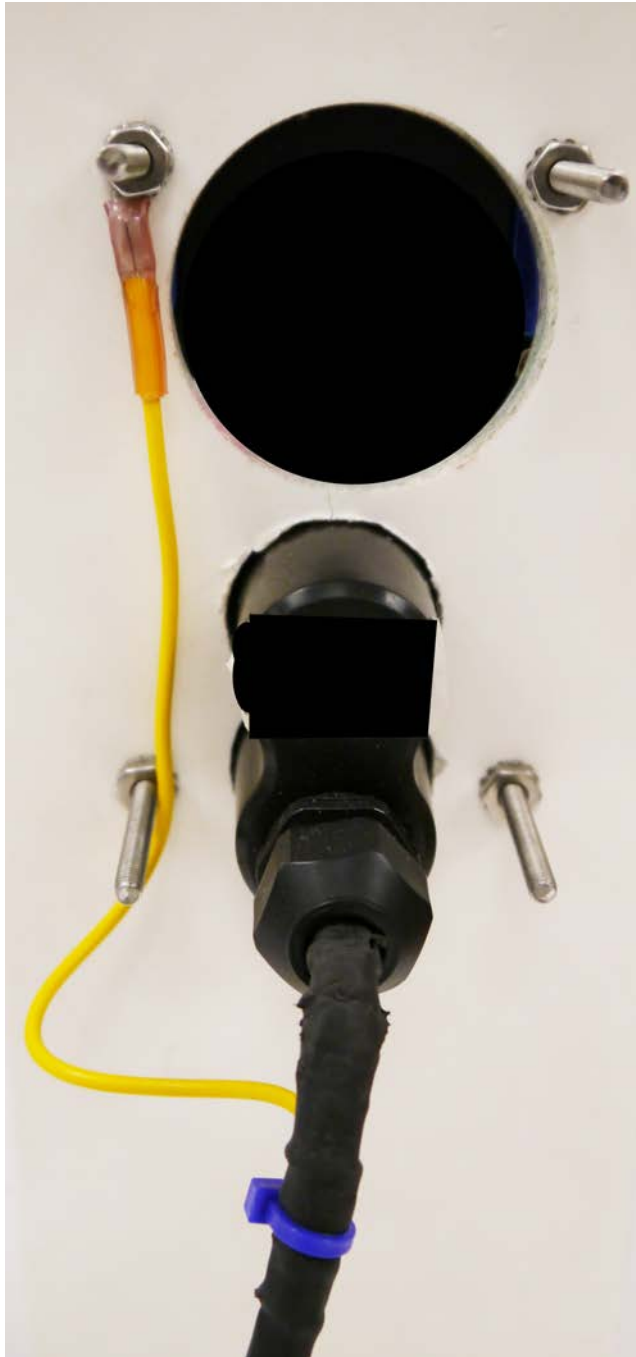

The Yellow Static Line can be attached to any of the four mounting studs for use.

Typical Installation

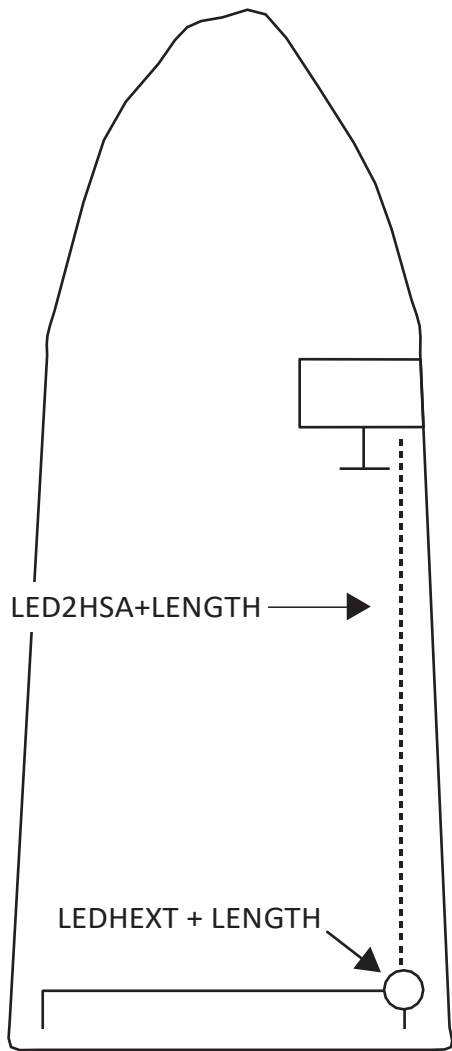

LEDHEXT + LENGTH
Designed to be installed on starboard side of boat

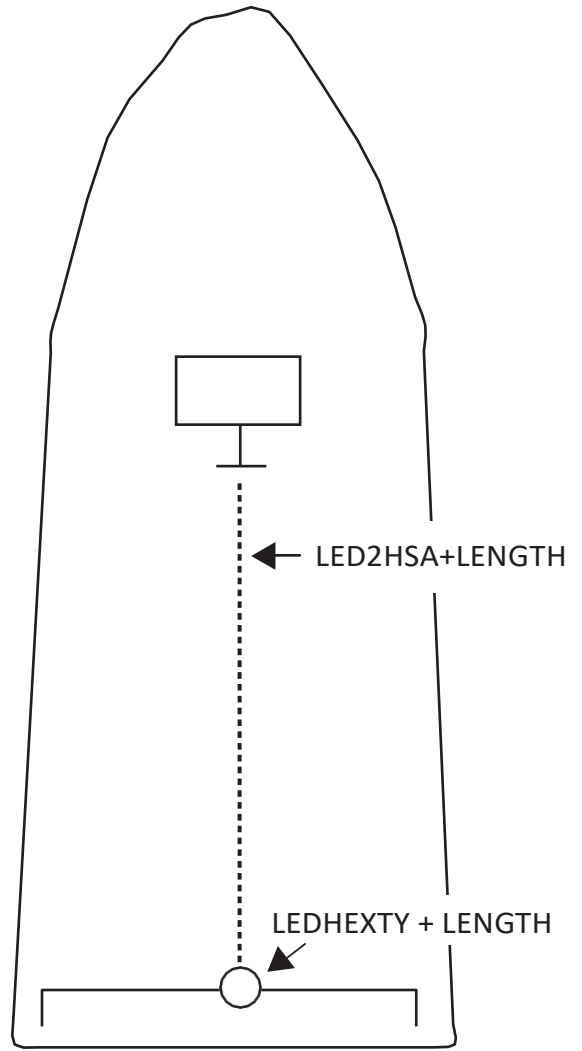

LEDHEXTY + LENGTH
Designed to be installed in center of boat

Typical NMEA 2000

DRIVES, TABS, FUEL LEVEL,
WATER LEVEL, ETC.

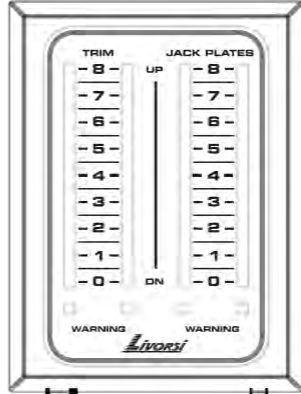

NMEA 2000 DATA FROM:
GATEWAY
VESSEL VIEW
MERC MONITOR
ETC.

FEMALE TERMINATOR
010-11081-00

LED2HNM30
HARNESS

MALE TERMINATOR
010-11080-00

T-CONNECTOR
010-11078-00

POWER CABLE
010-11079-00

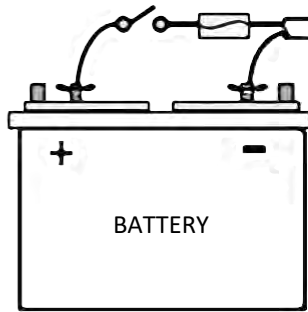

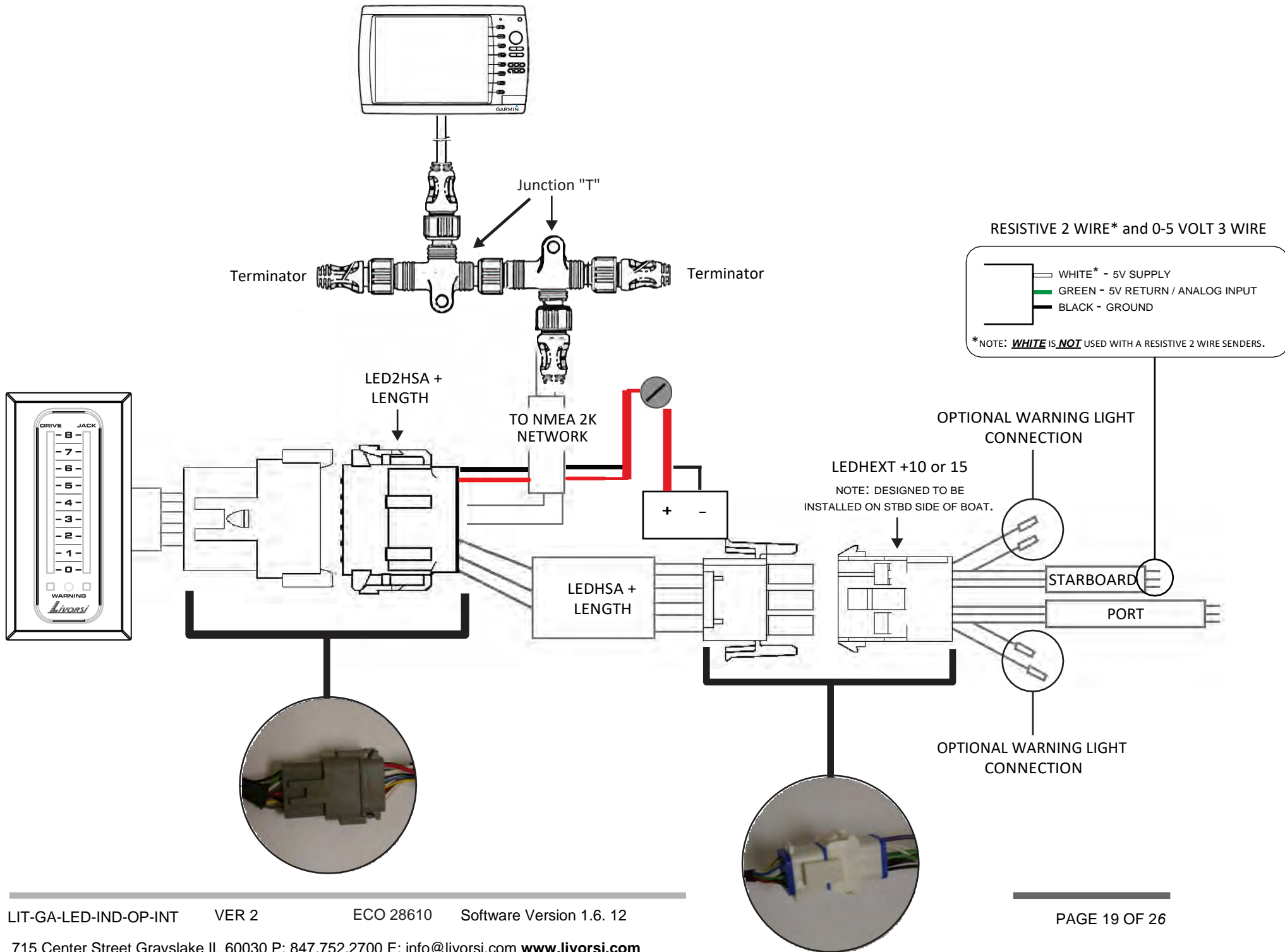

Outboards

MERCURY 3 WIRE OUTBOARD DIGITAL SENDER

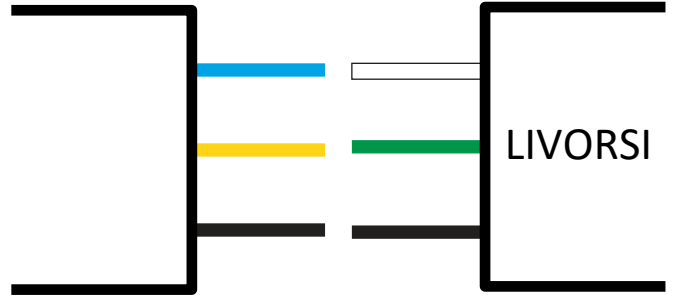

MERCURY 2 WIRE OUTBOARD ANALOG SENDER

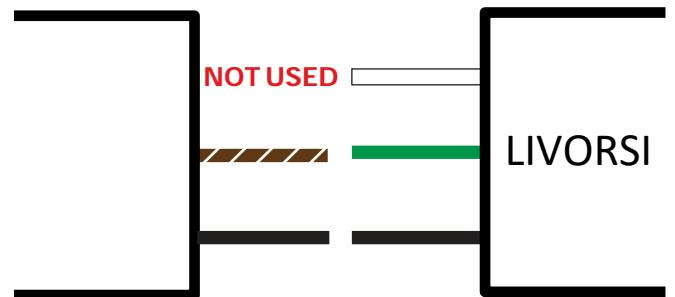

JOHNSON / EVINRUDE 2 WIRE OUTBOARD DIGITAL SENDER

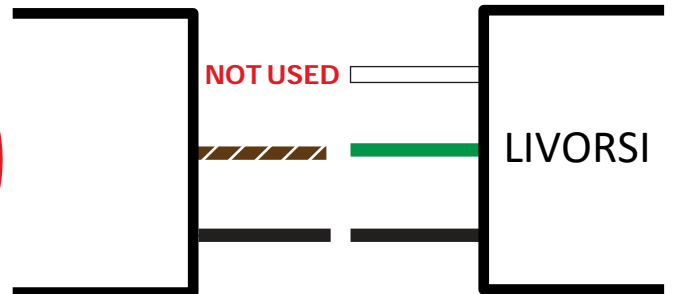
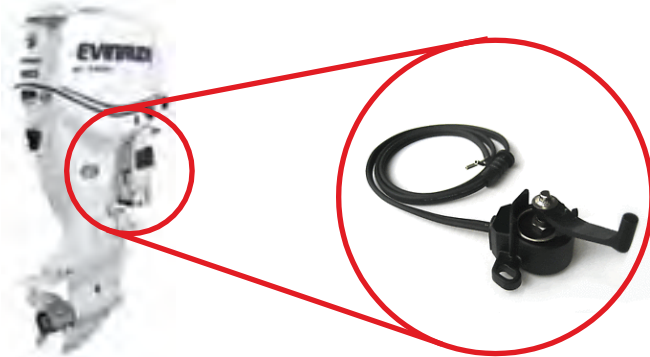

YAMAHA 2 WIRE OUTBOARD DIGITAL SENDER

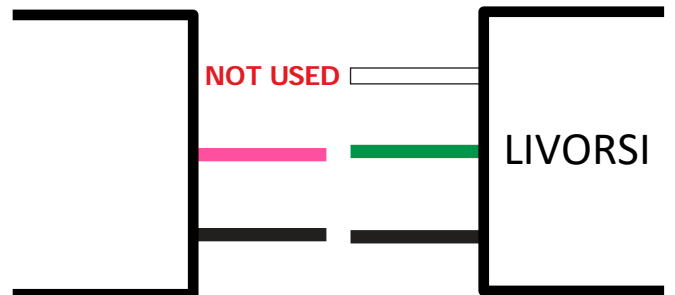

Outboards

SUZUKI 2 WIRE OUTBOARD DIGITAL SENDER

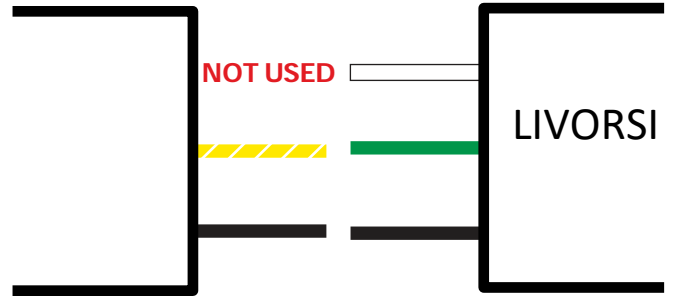

HONDA 2 WIRE OUTBOARD DIGITAL SENDER



TOHATSU 2 WIRE OUTBOARD DIGITAL SENDER

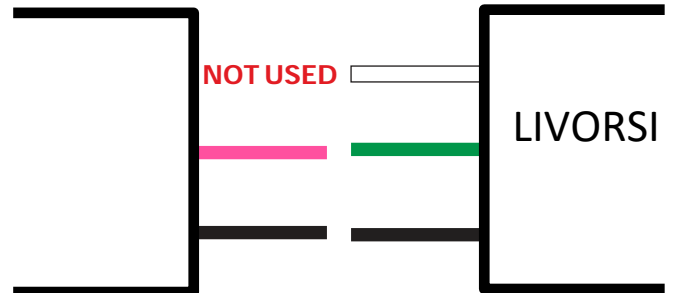

IO'S

MERCURY ALPHA IO ANALOG SENDER

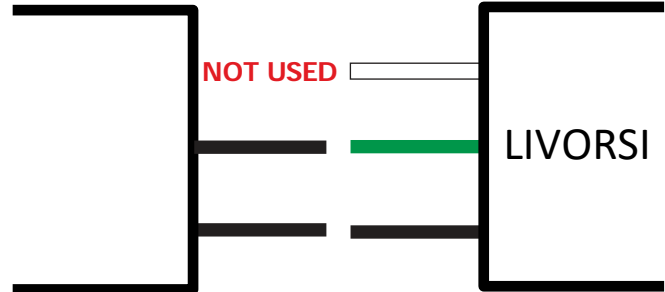

MERCURY BRAVO IO ANALOG SENDER

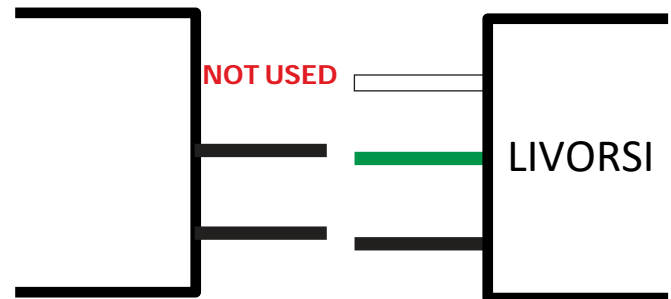
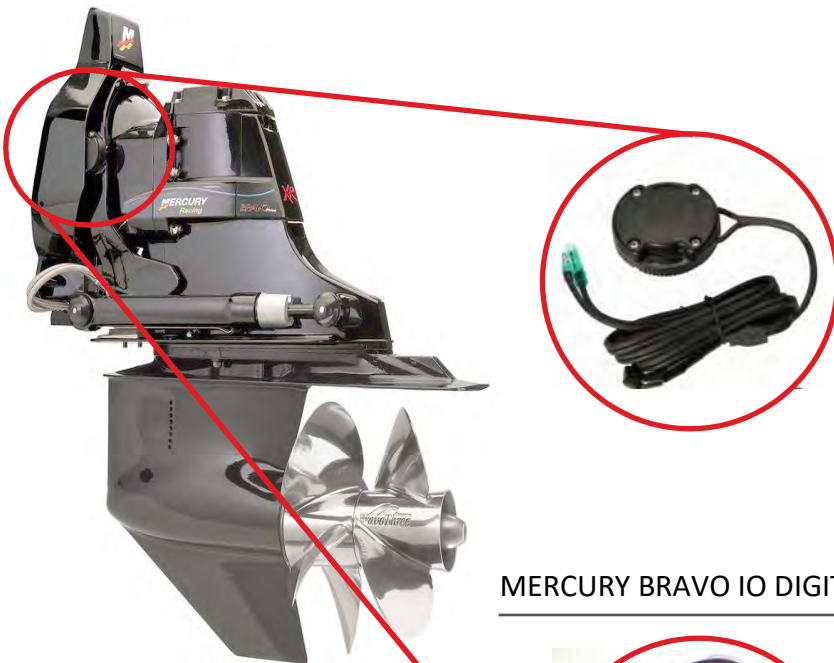

MERCURY BRAVO IO DIGITAL SENDER

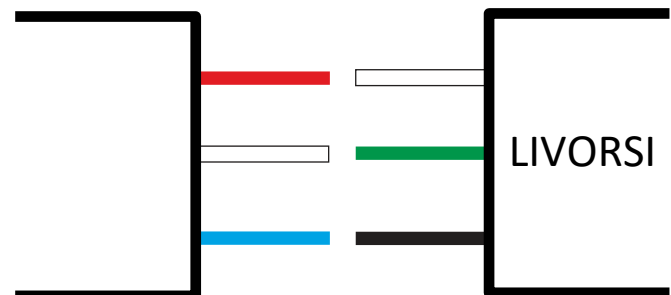

IO'S

VOLVA PENTA

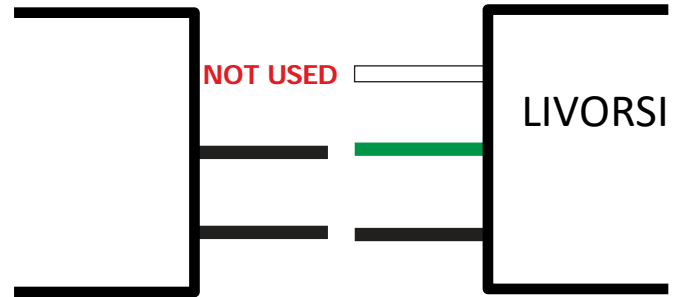
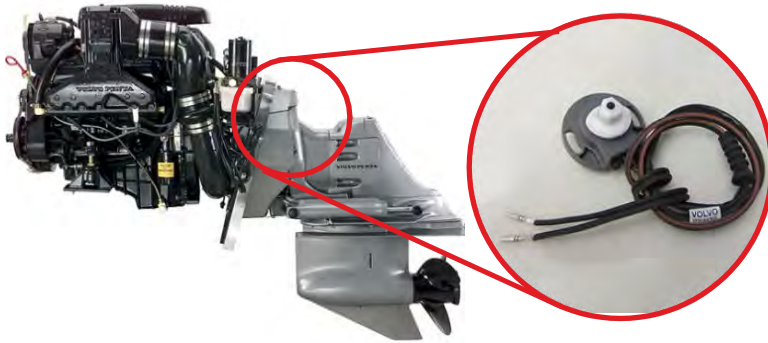

COBRA OMC

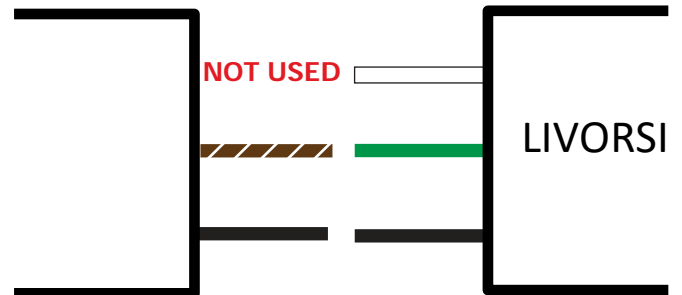

Fuel Senders

2 WIRE FUEL/WATER SENDER (ANALOG)

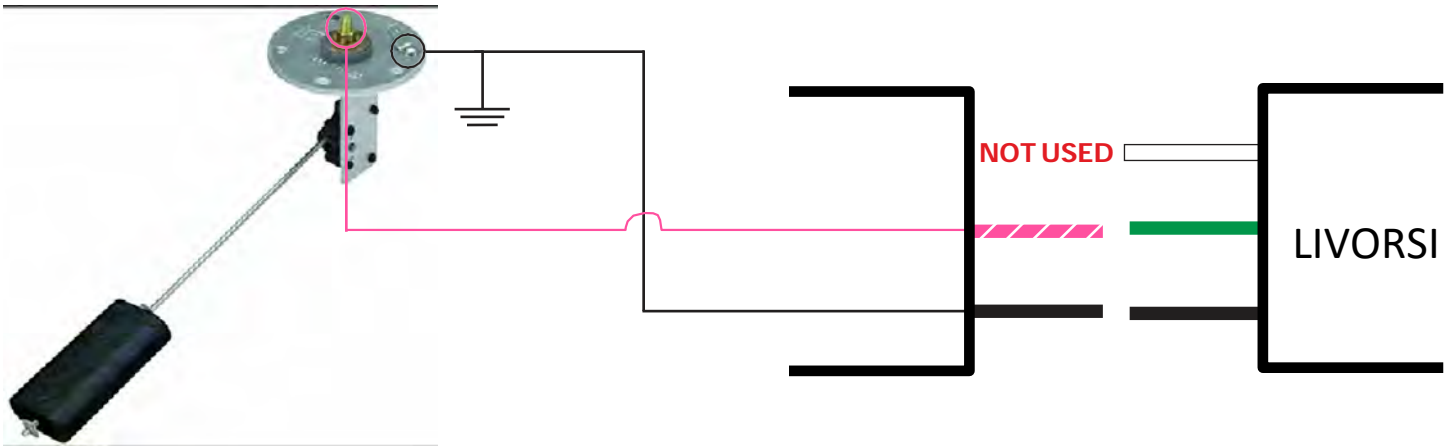

2 WIRE FUEL/WATER SENDER (ANALOG)

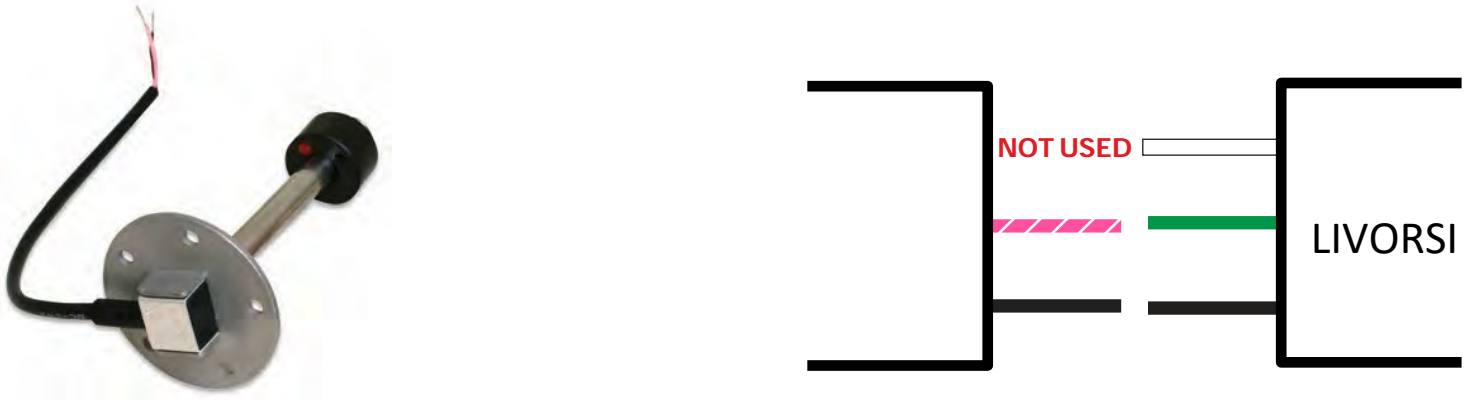

Trim Tabs

MERCURY TRIM TAB SENDER

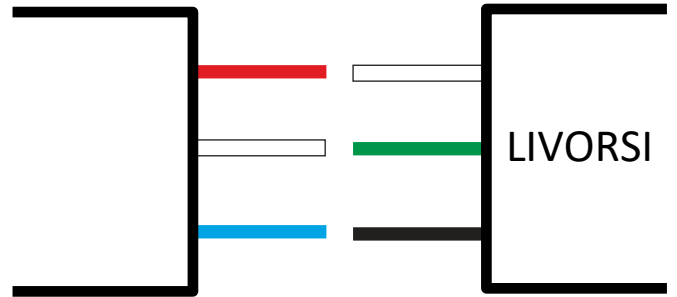

OR

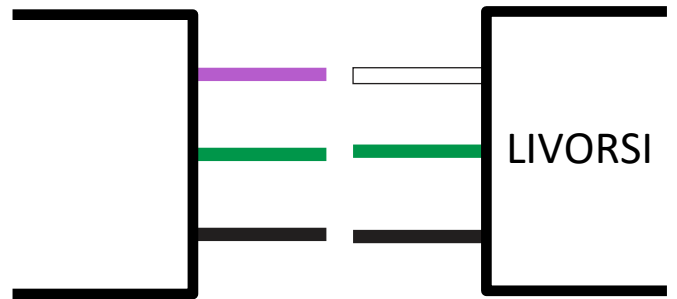

LIVORSI TRIM TAB SENDER

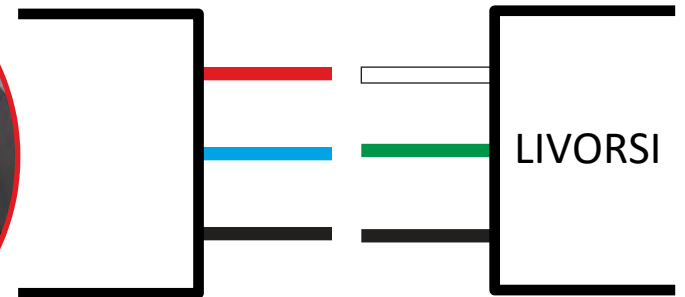

Adaptor harness - Part #TTIWH

CONVERTER BOX

CONVERTER BOX CBME5

