

## GPS SPEEDOMETER INSTALLATION

Mega and Race Series, Industrial Series Models  
**PART # GPSS and GPSL all colors**

### **Antenna Placement**

If you are using the supplied antenna, find a mounting location that will maintain an unobstructed view of the satellites.

Hidden installation of the antenna is possible and can be determined by temporarily mounting the antenna in the desired location and checking the signal.

Due to the differences in dash or deck thickness and materials, results are difficult to predict. The signals will not pass through metal, but may pass through glass and plexi windshields.

Additionally, try to keep the antenna away from any aluminum or stainless frames.

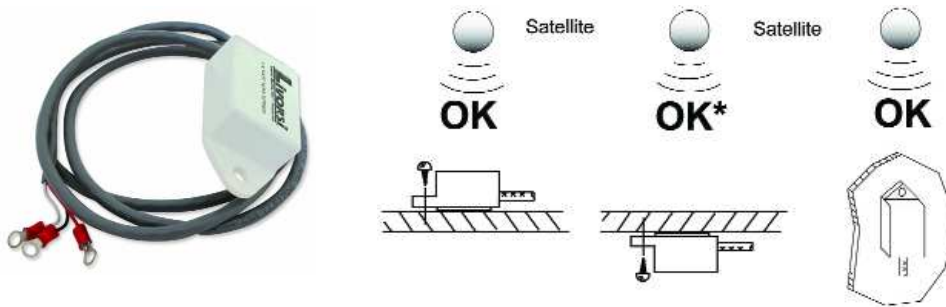

1. Once a location is chosen, drill a 3/8" (9.5 mm) opening in the mounting panel.
2. Slide the antenna cable in to the opening and secure the antenna with a screw or double sided tape.

If you are using an alternative antenna, make certain that its NMEA 0183 and that the wiring is compatible with the gauge.

### **Wire Connection**

White	Signal (NMEA 0183 output)
Red	Switched 12V power
Black	Good engine ground

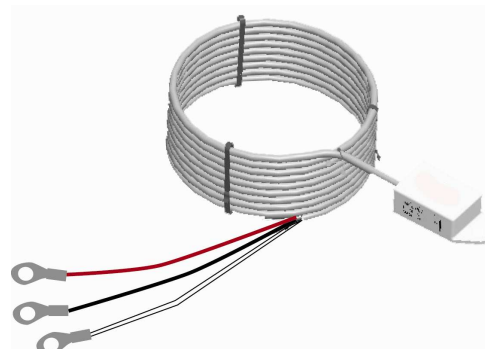

## Back of GPS Speedometer

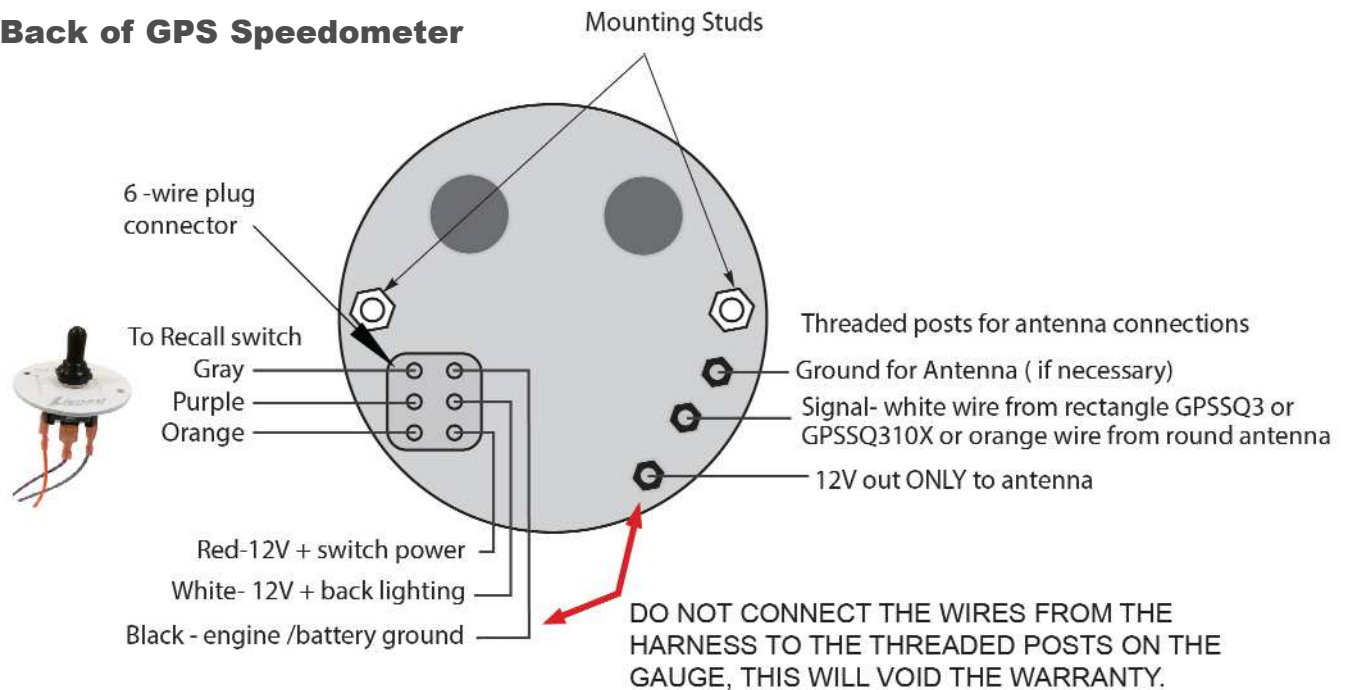

## Recall Switch Wiring

1. Find a suitable location for the recall switch, drill a 1/2" opening in the panel.
2. Center the opening in the panel with the opening on the cover plate, and mark the centers for the screws that will secure the cover plate to the panel. Secure the cover plate.
3. Make the appropriate connections on the switch.
  - Purple wire to the center terminal
  - Orange wire to the outside terminal on the same side as the "Recall" mark on the switch plate
  - Gray wire to the remaining terminal in the center
4. Fit the switch in to the opening, screw on the protective boot, and secure the switch with the nut from the other side of the panel.

**Warning:** Make certain that the purple wire is always connected to the center terminal. Short-circuiting of the orange and gray wires may lead to circuit failure and will void the warranty. Incorrect connections will void the warranty.

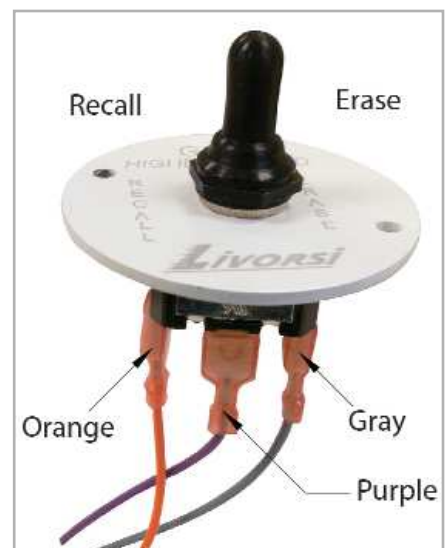

---

## Gauge

1. Cut out a 4 5/8" (117 mm) opening in the dash board for a GPSL series gauge  
Or a 3 3/8" (86 mm) opening for a GPSS series gauge.
2. If possible, slide the wiring harness through the opening and make all the electrical connections prior to fitting the gauge in to the panel. Otherwise mount the gauge first, and then make appropriate connections.

Note the proper way of connecting the GPS harness to the GPS speedometer.

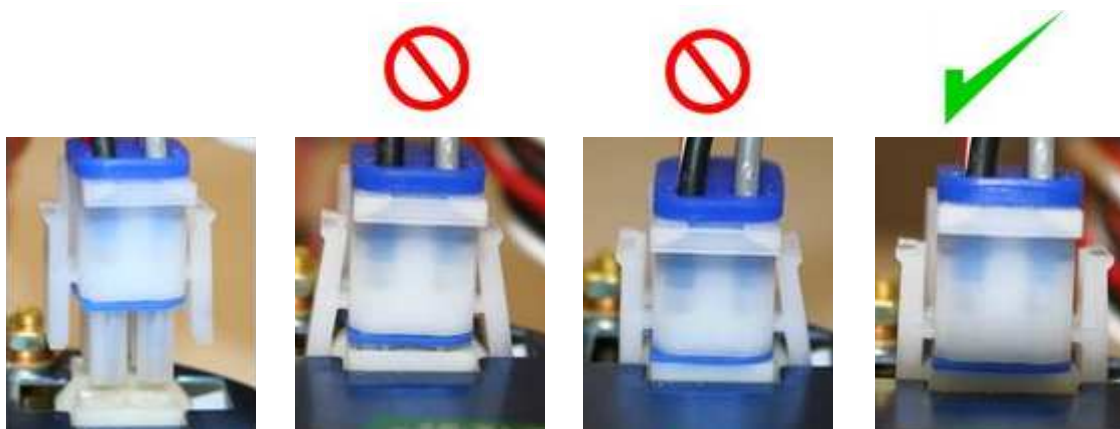

3. Fit the gauge in to the opening and rotate it to the desired position.
4. Slide the clamp over the mounting studs, and secure the clamp with provided nuts. Torque the nuts to 4-6 in-lbs.

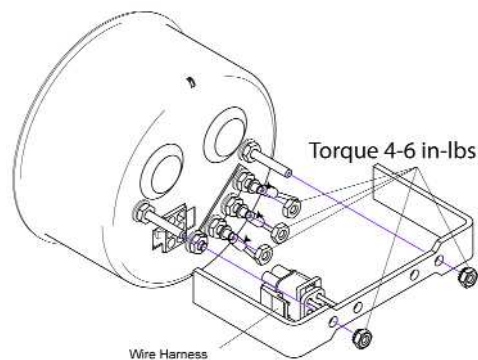

## Operation

When the gauge is powered up and the antenna is properly connected, it will go through a self test mode.

During this period

- the pointer will move to 3 o'clock position
- then immediately sweep to the 12 o'clock position
- then immediately move to the 6 o'clock position

\*\*\*\*For the GPSS50 or the GPSL50 the diagnostic mode will go as follows. the pointer will move to 6 o'clock position and then immediately sweep to the 3 o'clock position for approximately three seconds. It will then move to the 12 o'clock position for an additional three seconds and then return to 6 o'clock. After a moment, the pointer will go to the 8 o'clock position (zero).

This completes the self test mode.

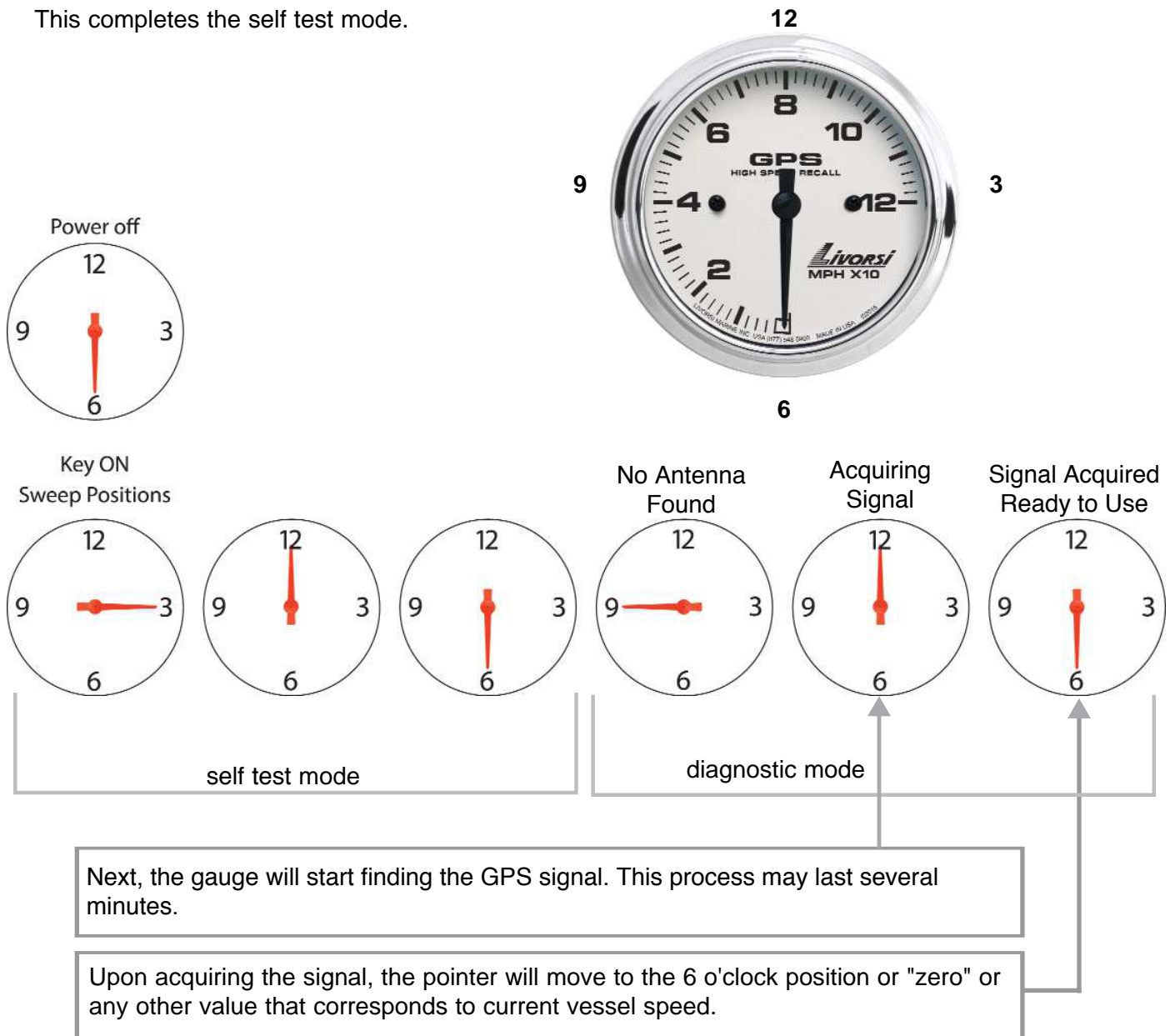

---

### **Recall Function**

The gauge is equipped with non-volatile memory that stores the highest attained speed. To display this speed simply toggle the switch in to the "Recall" position.

Note: The highest speed value will remain in memory even if there is no power to the gauge. To clear the memory, toggle the switch to the "Erase" position.

### **Trouble Shooting**

**Symptom:** The gauge appears to be non-functioning, no backlighting is present.

**Possible Cause:** There is no power to the gauge.

**Remedy:** Verify connections to the gauge.

**Symptom:** No pointer movement during start up, backlight is present.

**Possible Cause:** No power to the movement.

**Remedy:** Verify connections to the gauge. If correct, verify the line voltage (10-18 V DC) and polarity in the system.

**Symptom:** Pointer remains in the same position indefinitely after power-up.

**Possible Causes:** Bad or no connection to the antenna, bad antenna, no satellites in range.

**Remedy:** Verify antenna connections. If correct, attempt to move vessel to a different location. If relocation does not resolve the issue, replace the antenna.

**Symptom:** Pointer remains indefinitely in particular position after properly functioning.

**Possible Causes:** Lost antenna connection, damaged antenna or lost satellite signal.

**Remedy:** Verify antenna connections. If correct, and relocation of the vessel does nothing, replace antenna.

**For technical support please call the Livorsi Marine, Inc. office at 847-752-2700 or email [info@livorsi.com](mailto:info@livorsi.com)**